



## High Pressure Gate Valves [GHP]

NPS 1/2" (DN 15) ÷ NPS 16" (DN 400)  
 Class 600 ÷ Class 2500  
 PN 100 ÷ PN 400

### Design

- Closed-Die-Forged, welded construction or cast body
- Pressure seal design
- Rising stem (RS), outside screw and yoke (OS&Y)
- Split wedge type obturator
- Hard faced seats

### Applications

- Power plant, Chemical, Petrochemical, Refining, water supply and other

### Media

- Depending on the gate valves materials for: water, steam, gas, oil and other non-aggressive media.

### Pressure and temperature ratings

- Class 600 ÷ Class 2500
- Pressures up to 400 bar
- Temperatures up to 600 °C
- p/t according to EN 12156-1 and ASME B16.34 (Appendix A)

### Materials (table D.6.1)

- Carbon and heat resistant alloys

### Advantages

- Long service life
- Respect to emission standards
- Easy handling and maintenance

### Options

- Electric actuator
- Pneumatic actuator
- Hydraulic actuator
- Position indicator
- Limit switches
- Locking device
- Chain-wheel
- Spring loaded stuffing box (SLSB)
- With by-pass Valve
- With equalizing pipe and by-pass valves
- With equalizing pipe to the 3rd chamber
- With hole in the wedge
- With hole in the seat
- With connection for safety valve
- Flanges and welding ends according to: DIN, EN, GOST, etc.
- Other paint finishes are available upon customer's request

### Testing

- Every produced valve is tested according to API 598 or EN 12266

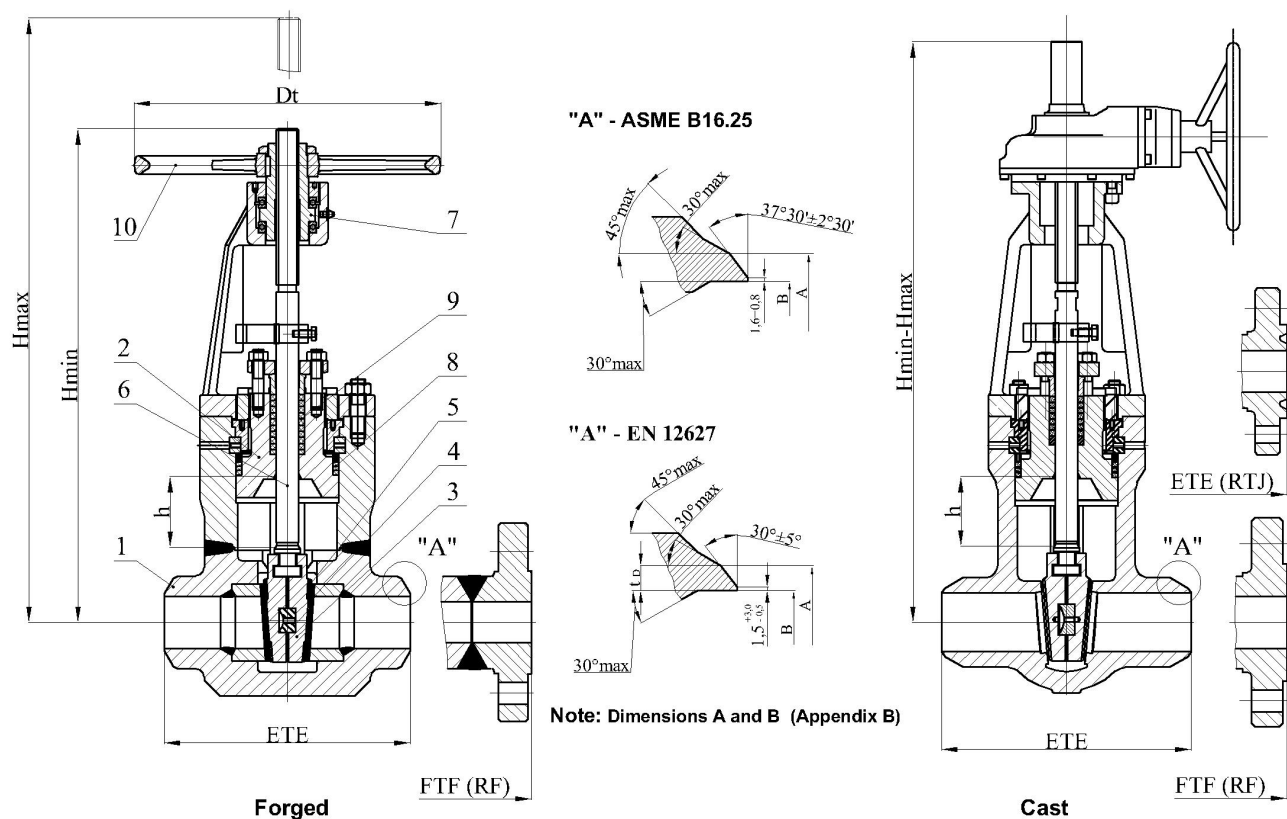

Drawing D.6.1 Parts and dimensions

List of materials

Table D.6.1

Item	Part	Material Group acc. to ASME B16.34 (EN 12516-1)				
		1.1 (3E0)	1.5 and 1.3 (4E0)	1.17 and 1.9 (5E0)	1.10 (6E0)	1.15 (9E1)
		Application				
		-29°C+425°C (up tp 400°C)	-29°C+470°C (up tp 530°C)	-29°C+595°C (up tp 550°C)	-29°C+595°C (up tp 600°C)	-29°C+600°C (up tp 600°C)
1	Body <sup>(1)</sup>	A105 / WCB (1.0460 / 1.0619)	F1 / WC1 (1.5415 / 1.5419)	F12 Cl.2 / WC6 (1.7335 / 1.7357)	F22 Cl.3 / WC9 (1.7383/1.7379)	F91 / C12A (1.4903 / 1.4955)
2	Bonnet <sup>(1)</sup>	A105 / WCB (1.0460 / 1.0619)	F1 / WC1 (1.5415 / 1.5419)	F12 Cl.2 / WC6 (1.7335 / 1.7357)	F22 Cl.3 / WC9 (1.7383/1.7379)	F91 / C12A (1.4903 / 1.4955)
3	Wedge <sup>(1)</sup>	A105 / WCB (1.0460 / 1.0619)	F1 / WC1 (1.5415 / 1.5419)	F12 Cl.2 / WC6 (1.7335 / 1.7357)	F22 Cl.3 / WC9 (1.7383/1.7379)	F91 / C12A (1.4903 / 1.4955)
4	Body Seat	Hard faced 13Cr or Stellite				
5	Wedge Seat	Hard faced 13Cr or Stellite				
6	Stem	1.4021 / 1.4122				
7	Stem Nut	1.0715 / 1.7225 / Cu alloy				
8	Bonnet Gasket	graphite with corrosion inhibitor				
9	Stem Packing	graphite with corrosion inhibitor				
10	Handwheel	Steel				

<sup>(1)</sup>other materials available acc. to ASTM specifications and EN standard

Standards

Table D.6.2

GHP	Class 600 ÷ Class 2500 and PN 100 ÷ PN 400
FTF and ETE according to	ASME B16.10 / EN 558 / EN 12982 / Manufacturer standard
Flanged ends according to	ASME B16.5 / EN 1092-1
Welding ends according to	ASME B16.25 / EN 12627

[GHP] Dimensions

Table D.6.3

Pressure Class (Nominal Pressure)	Nominal size (Diameter Nominal)	End - To - End		Face - To - Face (RF)	End-To-End (RTJ)	Centre-to-top (close)	Centre-to-top (open) (Gearbox)	Handwheel	Stroke	Flange for electric actuator ISO 5210 (DIN 3338-Form C)	Kvs	Mass		
		ETE	FTF									ETE	FTF	
Class (PN)	NPS (DN)	mm										m <sup>3</sup> /h	kg	
		ETE	FTF	ETE	Hmin	Hmax	D <sub>t</sub>	h	ETE	FTF				
Class 600 (PN 100) Cast and Forged	2" (50)	292		295	505	565	300	60	F10-B1	430	46	55		
	2 1/2" (65)	330		333	630	708	400	78	F10-B1	520	68	90		
	3" (80)	356		359	728	828	400	100	F10-B1	747	91	119		
	4" (100)	432		435	798	901	400	103	F10-C	1486	118	154		
	6" (150)	559		562	1038	1203	500	165	F14-B1	2741	376	425		
	8" (200)	660		663	1260	1470	630	210	F14-B1	5092	665	737		
	10" (250)	787		790	1585	1855	630	270	F14-B1	7890	1026	1242		
12" (300)	838		841	2045		gearbox	320	F14-B3	11457	1230	1402			
Class 900 (PN 160) Cast and Forged	2" (50)	368		371	555	630	300	75	F10-B1	290	47	68		
	2 1/2" (65)	419		422	638	716	400	78	F10-B1	420	78	100		
	3" (80)	381		384	735	835	400	100	F10-B1	683	107	141		
	4" (100)	356	457	460	798	913	400	115	F14-B1	1242	137	179		
	6" (150)	508	610	613	1100	1270	500	170	F14-B1	2745	403	528		
	8" (200)	660	737	740	1273	1493	630	220	F16-B1	4666	698	833		
	10" (250)	787	838	841	1875		gearbox	274	F14-B3	7283	1193	1444		
12" (300)	914	965	968	2045		gearbox	320	F14-B3	10254	1430	1630			
Class 1500 (PN 250) Cast and Forged	2" (50)	368		371	555	618	300	63	F10-B1	290	47	68		
	2 1/2" (65)	419		422	638	715	400	77	F10-C	420	78	100		
	3" (80)	470		473	753	848	400	95	F14-B1	628	124	170		
	4" (100)	406	546	549	827	942	400	115	F14-B1	1086	159	228		
	6" (150)	559	705	711	1322		gearbox	170	F14-B3	2392	438	574		
	8" (200)	711	832	842	1566		gearbox	220	F14-B3	4065	731	929		
	10" (250)	864	991	1001	1936		gearbox	274	F14-B3	6510	1388	1645		
	12" (300)	991	1130	1146	2131		gearbox	320	F16-B3	8921	1958	2520		
	14" (350)	1067	1257	1276	2316		gearbox	380	F16-B3	10725	2028	2865		
16" (400)	1194	1384	1406	2541		gearbox	425	F16-B3	14020	3557	4145			
Class 2500 (PN 400) Cast and Forged	2" (50)	451		354	507	562	300	55	F10-B1	187	65	94		
	2 1/2" (65)	508		514	622	702	400	80	F14-B1	290	97	141		
	3" (80)	578		584	735	830	500	95	F14-B1	421	130	178		
	4" (100)	457	673	683	806	931	500	125	F14-B1	685	225	360		
	6" (150)	610	914	927	1320		gearbox	170	F14-B3	2173	581	771		
	8" (200)	762	1022	1038	1616		gearbox	220	F14-B3	2741	1164	1540		
	10" (250)	914	1270	1292	1972		gearbox	285	F16-B3	4353	2330	3030		
	12" (300)	1041	1422	1444	2285		gearbox	320	F16-B3	6167	3860	5404		
Closed-Die-Forged body														
Class 1500 (PN 250) Forged	1/2" (15)	100	180	180	253	272	150	19	F10-B1	21	5,2	11		
	3/4" (20)	110	210	210	253	272	150	19	F10-B1	39	5,5	13		
	1" (25)	140	254	254	305	336	200	31	F10-B1	63	13	23		
	1 1/4" (32)	165	279	279	378	411	250	33	F10-B1	104	22	43		
	1 1/2" (40)	178	305	305	378	424	250	46	F10-B1	156	24	54		
Class 2500 (PN 400) Forged	1/2" (15)	100	264	264	253	272	150	16	F10-B1	16	5,2	13		
	3/4" (20)	110	273	273	253	272	150	18	F10-B1	26	5,5	16		
	1" (25)	186	308	308	305	336	200	24	F10-B1	47	13	26		
	1 1/4" (32)	232	349	352	378	411	250	33	F10-B1	83	22	48		
	1 1/2" (40)	232	384	387	378	424	250	46	F10-B1	104	24	60		

Dimensions of flanged connections are given in Appendix C.

**Optional execution**

**Type of operations**

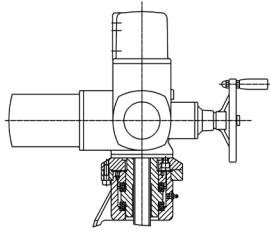

Electric actuator

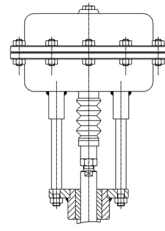

Pneumatic actuator

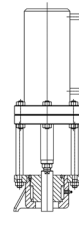

Hydraulic actuator

**Accessories**

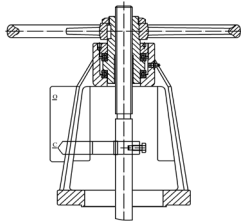

Position indicator

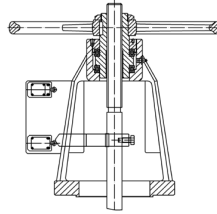

Limit switches

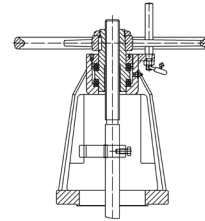

Locking devices

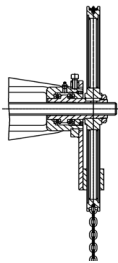

Chain-wheel

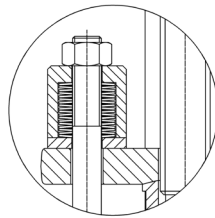

Spring loaded stuffing box (SLSB)

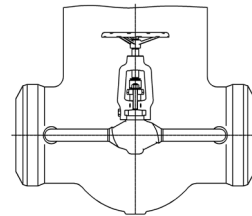

With by-pass

**Over pressure safety devices**

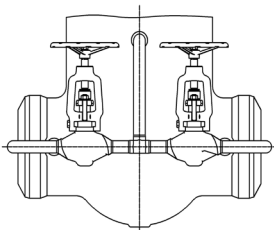

With equalizing pipe and by-pass

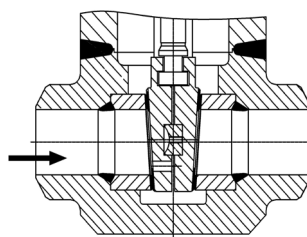

With hole in the wedge

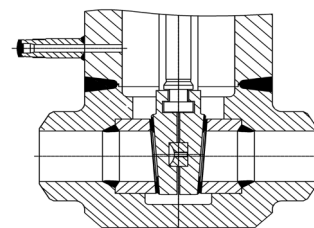

With conection for safety valve

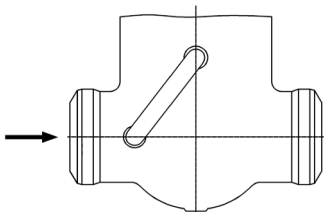

With equalizing pipe to the 3<sup>rd</sup> chamber

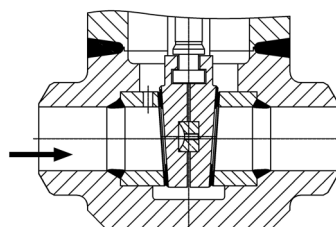

With hole in the seat